

6000h at 85°C

- Long Life at 85°C
- High Ripple Current
- Long Life General Industrial Electronics

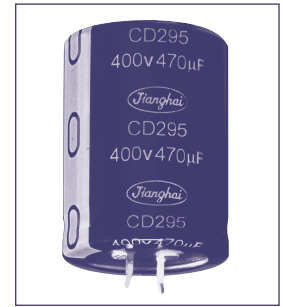
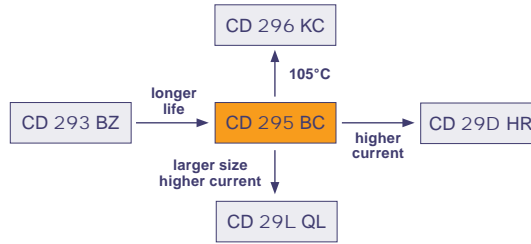

Item	Characteristics	
Operating Temperature Range (°C)	-40 ~ +85	-25 ~ +85
Voltage Range (V)	10 ~ 400	450
Capacitance Range (µF)	68 ~ 22 000	
Capacitance Tolerance (20°C, 120Hz)	± 20%	
Leakage Current (µA)	After 5 minutes at 20°C application of rated voltage, leakage current is not more than 0,01CV or 1,5mA, whichever is smaller C: Nominal Capacitance (µF) V: Rated Voltage (V)	
Dissipation Factor (20°C, 120Hz)	Rated Voltage (V)	10 16 25 35 50 63~100 160~250 315~450
	Tan δ (max)	0,80 0,60 0,50 0,40 0,30 0,20 0,15 0,15
Stability at Low Temperature (Impedance Ratio at 120Hz)	Rated Voltage (V)	10 16~35 50~100 160~200 250~400 450
	Z _{-25°C} / Z _{+20°C}	5 4 3 4
	Z _{-40°C} / Z _{+20°C}	18 15 10 6 8 -

	Useful Life		Load Life	Endurance Test	Shelf Life
Lifetime	6 000h	>100 000h	5 000h	5 000h	1 000h
Leakage Current	Not more than specified value		Not more than specified value	Not more than specified value	Not more than specified value
Capacity Change	Within ± 30% of initial value		Within ± 20% of initial value	Within ± 20% of initial value	Within ± 20% of initial value
Dissipation Factor	Not more than 300% of specified value		Not more than 200% of specified value	Not more than 130% of specified value	Not more than 200% of specified value
Condition:	U _R		U _R	U _R	U _R = 0
Applied Voltage	U _R		U _R	U _R	U _R = 0
Applied Current	I _R		I _R	I _R = 0	I _R = 0
Applied Temperature	85°C		85°C	85°C	85°C
Failure Rate Level	≤ 1% Failure Rate		guaranteed		After test: U _R to be applied for 30min >24h before measurement

Multiplier for Ripple Current

Frequency Coefficient

Rated Voltage (V)	Frequency				
	50Hz	120Hz	1kHz	10kHz	100kHz
≤ 50	0,95	1,00	1,10	1,15	1,15
63 ~ 100	0,95	1,00	1,16	1,30	1,33
≥ 160	0,90	1,00	1,20	1,50	1,55

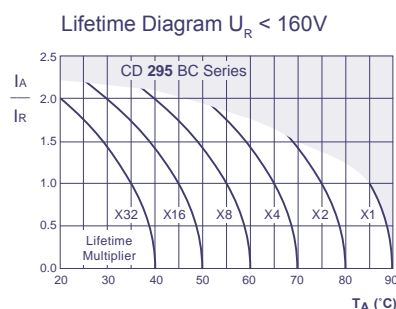

I_A = actual ripple current at 120Hz,
I_R = rated ripple current at 120Hz, 85°C
Multiplier of Useful Life as a function of ambient temperature and ripple current load

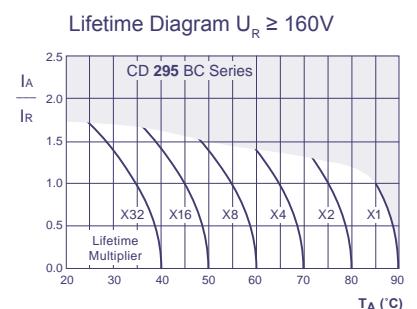

I_A = actual ripple current at 120Hz,
I_R = rated ripple current at 120Hz, 85°C
Multiplier of Useful Life as a function of ambient temperature and ripple current load



Snap-In

V _{DC} (Surge Voltage) Code	Rated Capacitance	Max ESR 20°C, 120Hz	Typ ESR 20°C, 120Hz	Max Ripple Current 85°C, 120Hz	Size Ø D x L
(V)	(µF)	(mΩ)	(mΩ)	(Arms)	(mm)
10 (13) 1A	10000	107	75	2.5	22 x 25
	12000	89	62	2.7	22 x 25
	15000	71	50	3.2	22 x 30
		71	50	3.1	25 x 25
	18000	59	42	3.6	22 x 35
		59	42	3.6	25 x 30
	22000	49	34	4.0	22 x 40
49		34	4.1	25 x 35	
49		34	4.1	30 x 25	
16 (20) 1C	8200	98	68	2.2	22 x 25
	10000	80	56	2.6	22 x 30
		80	56	2.6	25 x 25
	12000	67	47	2.9	22 x 35
	15000	54	38	3.3	22 x 40
		54	38	3.3	25 x 30
		54	38	3.4	30 x 25
	18000	45	31	3.8	22 x 45
		45	31	3.7	25 x 35
	22000	37	26	4.2	22 x 50
		37	26	4.2	25 x 40
		37	26	4.2	30 x 30
	25 (32) 1E	5600	119	83	2.0
6800		98	69	2.3	22 x 30
		98	69	2.3	25 x 25
8200		81	57	2.6	22 x 35
10000		67	47	2.9	22 x 40
		67	47	2.8	25 x 30
12000		67	47	3.0	30 x 25
		56	39	3.3	22 x 45
15000		56	39	3.2	25 x 35
		56	39	3.4	30 x 30
18000		45	31	3.7	25 x 40
		45	31	3.9	35 x 25
22000		37	26	4.3	25 x 50
		37	26	4.2	30 x 35
		37	26	4.4	35 x 30
35 (44) 1V	3300	161	113	1.8	22 x 25
	3900	137	96	2.1	22 x 30
	4700	113	80	2.2	25 x 25
	5600	95	67	2.3	22 x 35
		95	67	2.3	25 x 30
	6800	79	55	2.9	22 x 40
		79	55	2.6	25 x 35
	8200	79	55	2.7	30 x 25
		65	46	2.8	22 x 50
		65	46	2.8	25 x 40
	10000	65	46	2.8	30 x 30
		65	46	2.9	35 x 25
		54	38	3.1	25 x 45
	12000	54	38	3.2	30 x 35
		45	31	3.5	25 x 50
	15000	45	31	3.5	30 x 40
		45	31	3.6	35 x 30
	18000	36	25	4.1	30 x 45
		36	25	4.1	35 x 35
	22000	30	21	4.6	30 x 50
		30	21	4.7	35 x 40
50 (63) 1H	2200	181	127	1.7	22 x 25
	2700	148	104	1.9	22 x 30
	3300	148	104	1.9	25 x 25
	3900	121	85	2.0	25 x 30
		103	72	2.1	22 x 35
	4700	103	72	2.1	25 x 30
		103	72	2.4	30 x 25
	5600	85	60	2.4	22 x 40
		85	60	2.4	25 x 35
		72	50	2.5	22 x 50
	6800	72	50	2.5	25 x 40
		72	50	2.5	30 x 30
	8200	72	50	2.6	35 x 25
		59	41	2.8	25 x 45
	10000	59	41	2.8	30 x 35
49		34	3.2	25 x 50	
12000	49	34	3.0	30 x 40	
	49	34	3.0	35 x 30	
15000	40	28	3.4	30 x 45	
	40	28	3.4	35 x 35	
	34	24	3.8	30 x 50	
	34	24	3.8	35 x 40	
	27	19	4.5	35 x 50	

V _{DC} (Surge Voltage) Code	Rated Capacitance	Max ESR 20°C, 120Hz	Typ ESR 20°C, 120Hz	Max Ripple Current 85°C, 120Hz	Size Ø D x L
(V)	(µF)	(mΩ)	(mΩ)	(Arms)	(mm)
63 (79) 1J	1500	177	124	1.6	22 x 25
	1800	148	104	1.8	22 x 25
	2200	121	85	2.0	22 x 30
		121	85	2.0	25 x 25
	2700	99	69	2.2	22 x 35
		99	69	2.3	25 x 30
	3300	81	57	2.3	22 x 40
		81	57	2.3	25 x 35
		81	57	2.3	30 x 25
	3900	68	48	2.5	22 x 45
		68	48	2.6	25 x 40
		68	48	2.6	30 x 30
	4700	68	48	2.7	35 x 25
		57	40	2.9	30 x 30
	5600	48	34	3.1	25 x 45
48		34	3.2	30 x 35	
6800	48	34	3.3	35 x 30	
	40	28	3.6	30 x 40	
8200	40	28	3.7	35 x 35	
	33	23	3.7	30 x 50	
10000	33	23	3.8	35 x 40	
	27	19	4.3	35 x 45	
12000	23	16	4.8	35 x 50	
80 (100) 1K	1000	266	186	1.3	22 x 25
	1200	222	155	1.5	22 x 30
	1500	177	124	1.7	25 x 25
	1800	148	104	1.9	22 x 35
		148	104	1.9	25 x 30
	2200	121	85	2.1	22 x 40
		121	85	2.2	25 x 35
	2700	121	85	2.2	30 x 25
		99	69	2.5	22 x 50
	3300	99	69	2.5	25 x 40
		99	69	2.5	30 x 30
	3900	99	69	2.5	35 x 25
		81	57	2.8	25 x 45
	4700	81	57	2.8	30 x 35
		68	48	3.1	25 x 50
5600	68	48	3.2	30 x 40	
	68	48	3.2	35 x 30	
6800	68	48	3.2	35 x 40	
	48	34	3.8	30 x 50	
8200	48	34	3.8	35 x 40	
	39	28	4.1	35 x 50	
100 (125) 2A	680	391	274	1.1	22 x 25
	820	324	227	1.2	22 x 30
	1000	266	186	1.4	25 x 25
	1200	222	155	1.6	22 x 35
		222	155	1.6	25 x 30
	1500	177	124	1.8	22 x 40
		177	124	1.7	25 x 35
	1800	177	124	1.8	30 x 25
		148	104	2.1	22 x 50
	2200	148	104	2.0	25 x 40
		148	104	2.1	30 x 30
	2700	148	104	2.2	35 x 25
		121	85	2.2	25 x 45
	3300	121	85	2.2	25 x 45
		121	85	2.3	30 x 35
3900	121	85	2.5	35 x 30	
	99	69	2.6	25 x 50	
4700	99	69	2.7	30 x 40	
	81	57	3.0	30 x 45	
5600	81	57	3.1	35 x 35	
	68	48	3.4	30 x 50	
6800	68	48	3.4	35 x 40	
	68	48	3.4	35 x 50	
160 (200) 2C	220	905	634	1.0	22 x 25
	270	737	516	1.1	22 x 25
	330	603	423	1.3	22 x 25
	390	511	358	1.5	22 x 30
		511	358	1.5	25 x 25
	470	424	297	1.7	25 x 25
		356	249	1.9	22 x 35
	560	356	249	1.9	25 x 30
		356	249	2.0	30 x 25
	680	293	205	2.1	22 x 40
		293	205	2.2	25 x 35
	820	243	170	2.5	22 x 50
		243	170	2.4	25 x 40
		243	170	2.5	30 x 30
	1000	243	170	2.4	35 x 25
199		140	2.7	25 x 45	
199		140	2.8	30 x 35	
	199	140	2.7	35 x 30	

V _{DC} (Surge Voltage) Code	Rated Capacitance	Max ESR 20°C, 120Hz	Typ ESR 20°C, 120Hz	Max Ripple Current 85°C, 120Hz	Size Ø D x L	
(V)	(µF)	(mΩ)	(mΩ)	(Arms)	(mm)	
160 (200) 2C	1200	166	117	3,1	25 x 50	
		166	117	3,2	30 x 40	
		166	117	3,0	35 x 35	
	1500	133	93	3,7	30 x 45	
		133	93	3,5	35 x 40	
	1800	111	78	3,9	35 x 45	
180 (225) 2K	2200	91	64	4,5	35 x 50	
	270	737	516	1,2	22 x 25	
		330	603	423	1,4	22 x 30
		390	511	358	1,5	25 x 25
	470	424	297	1,7	22 x 35	
		424	297	1,7	25 x 30	
		424	297	1,8	30 x 25	
	560	356	249	1,9	22 x 40	
		356	249	2,0	25 x 35	
	680	293	205	2,3	22 x 50	
		293	205	2,2	25 x 40	
		293	205	2,3	30 x 30	
	820	243	170	2,5	25 x 45	
		243	170	2,6	30 x 35	
		243	170	2,5	35 x 30	
	1000	199	140	2,9	25 x 50	
		199	140	2,9	30 x 40	
	200 (250) 2D	1200	166	117	3,3	30 x 45
		1500	166	117	3,1	35 x 35
		1800	133	93	3,6	35 x 45
			111	78	4,1	35 x 50
		220	905	634	1,1	22 x 25
		270	737	516	1,2	22 x 25
		330	603	423	1,4	22 x 30
603			423	1,4	25 x 25	
390		511	358	1,6	22 x 35	
		511	358	1,6	25 x 30	
470		424	297	1,8	22 x 40	
		424	297	1,9	30 x 25	
560	356	249	2,0	22 x 45		
	356	249	2,0	25 x 35		
	356	249	2,1	30 x 30		
	356	249	2,0	35 x 25		
680	293	205	2,3	25 x 40		
	293	205	2,4	30 x 35		
820	243	170	2,6	25 x 50		
	243	170	2,7	30 x 40		
	243	170	2,5	35 x 30		
1000	199	140	3,1	30 x 45		
	199	140	2,8	35 x 35		
1200	166	117	3,4	30 x 50		
	166	117	3,2	35 x 40		
1500	133	93	3,8	35 x 50		
250 (300) 2E	100	1990	1393	0,72	22 x 25	
	180	1106	774	0,94	22 x 25	
	220	905	634	1,1	22 x 30	
		905	634	1,1	25 x 25	
	270	737	516	1,2	22 x 35	
		603	423	1,4	22 x 40	
	330	603	423	1,4	25 x 30	
		603	423	1,5	30 x 25	
	390	511	358	1,6	22 x 45	
		511	358	1,6	25 x 35	
	470	424	297	1,8	22 x 50	
		424	297	1,8	25 x 40	
		424	297	1,8	30 x 30	
	560	424	297	1,9	35 x 25	
		356	249	2,0	25 x 45	
	680	356	249	2,0	30 x 35	
		293	205	2,3	30 x 40	
	820	293	205	2,4	35 x 30	
		243	170	2,6	30 x 45	
	1000	243	170	2,6	35 x 35	
		199	140	3,0	35 x 40	
	1200	166	117	3,4	35 x 45	
	315 (365) 2F	100	1990	1393	0,67	22 x 25
		120	1658	1161	0,75	22 x 30
150		1327	929	0,85	22 x 30	
		1327	929	0,85	25 x 25	
180		1106	774	0,96	22 x 35	
		1106	774	0,96	25 x 30	
220		905	634	1,1	22 x 40	
		905	634	1,1	25 x 35	
		905	634	1,1	30 x 25	
270		737	516	1,2	22 x 45	
		737	516	1,3	25 x 40	
		737	516	1,3	30 x 30	
	737	516	1,3	35 x 25		

V _{DC} (Surge Voltage) Code	Rated Capacitance	Max ESR 20°C, 120Hz	Typ ESR 20°C, 120Hz	Max Ripple Current 85°C, 120Hz	Size Ø D x L	
(V)	(µF)	(mΩ)	(mΩ)	(Arms)	(mm)	
315 (365) 2F	330	603	423	1,4	25 x 45	
		603	423	1,4	30 x 35	
		511	358	1,6	25 x 50	
	390	511	358	1,6	30 x 40	
		511	358	1,6	35 x 30	
	470	424	297	1,8	30 x 45	
		424	297	1,8	35 x 35	
	560	356	249	2,0	30 x 50	
		356	249	2,0	35 x 40	
	680	293	205	2,3	35 x 45	
	350 (400) 2V	82	2427	1699	0,64	22 x 25
		100	1990	1393	0,72	22 x 25
120		1658	1161	0,82	22 x 30	
		1658	1161	0,81	25 x 25	
150		1327	929	0,94	22 x 35	
		1327	929	0,94	25 x 30	
180		1106	774	1,1	22 x 40	
		1106	774	1,1	30 x 25	
220		905	634	1,2	22 x 45	
		905	634	1,2	25 x 35	
		905	634	1,2	30 x 30	
270		905	634	1,3	35 x 25	
	737	516	1,4	25 x 45		
400 (450) 2G	330	737	516	1,4	30 x 35	
		603	423	1,6	25 x 50	
	390	603	423	1,6	35 x 30	
		511	358	1,7	30 x 40	
	470	511	358	1,8	35 x 35	
		424	297	2,0	30 x 45	
	560	424	297	2,0	35 x 40	
		356	249	2,3	35 x 45	
	820	293	205	2,6	35 x 50	
	450 (500) 2W	82	2427	1699	0,55	22 x 25
		68	2926	2048	0,55	22 x 25
		82	2427	1699	0,60	22 x 25
100		1990	1393	0,70	22 x 30	
		1990	1393	0,70	25 x 25	
120		1658	1161	0,79	22 x 35	
		1327	929	0,90	22 x 40	
150		1327	929	0,89	25 x 30	
		1327	929	0,95	30 x 25	
180		1106	774	1,0	22 x 45	
		1106	774	1,0	25 x 35	
		1106	774	1,1	30 x 30	
220	1106	774	1,2	35 x 25		
	905	634	1,1	22 x 50		
	905	634	1,2	25 x 40		
270	905	634	1,2	30 x 35		
	737	516	1,3	25 x 45		
500 (550) 2X	330	737	516	1,4	30 x 40	
		737	516	1,6	35 x 30	
	390	603	423	1,6	30 x 45	
		603	423	1,7	35 x 35	
	470	511	358	1,8	30 x 50	
		511	358	1,8	35 x 40	
	560	424	297	2,1	35 x 45	
		356	249	2,3	35 x 50	
	68	2926	2048	0,57	22 x 30	
	82	2427	1699	0,64	22 x 35	
		1990	1393	0,72	22 x 35	
	100	1990	1393	0,73	25 x 30	
1658		1161	0,80	22 x 40		
120	1658	1161	0,83	25 x 35		
	1327	929	0,95	22 x 50		
150	1327	929	0,95	25 x 40		
	1327	929	0,98	30 x 30		
180	1106	774	1,1	25 x 45		
	1106	774	1,1	30 x 35		
	1106	774	1,2	35 x 25		
220	905	634	1,2	25 x 50		
	905	634	1,3	30 x 40		
	905	634	1,3	35 x 30		
270	737	516	1,4	30 x 45		
	737	516	1,5	35 x 35		
	603	423	1,7	30 x 50		
390	511	358	1,9	35 x 45		
	424	297	2,2	35 x 50		

Order Code SMD, Radial, Snap-In

EC	R	1C	PT	101	M	FF	25	0611	JE xxxxx
Technology	Terminal Type	Rated Voltage Code	Series Code	Capacitance Code (in μF)	Capacitance Tolerance	Lead Form	Terminal/Pitch Size	Dimension	for Specials only
EC = Electrolytic Capacitor	SMD = V	For coding please refer to the pages of ratings	CD VS = BS	0,47 = R47	$\pm 20\%$ = M	SMD:		4x7 = 0407	
	Radial = R		CD VH = VH	1,0 = 010	$\pm 10\%$ = K	Taped = FF	Terminal = T2	5x11,5 = 0511	
PC = Polymer Capacitor	Snap-In = S		CD VZ = VZ	2,2 = 2R2	+30 / -10% = Q	Radial:		6,3x11,5 = 0611	
			CD 261 = LK	100 = 101	+50 / -10% = T	Long Lead = LL	2,0mm = 20	35x80 = 3580	
			CD 261X = QX	1000 = 102		Cut 5,0mm = CB	2,5mm = 25	45x100 = 45100	
			CD 262 = QM	10000 = 103		Cut 4,5mm = CC	3,5mm = 35		
			CD 263 = BK			Cut 4,0mm = CD	5,0mm = 50		
			CD 269 = PH			Cut 3,5mm = CE	7,5mm = 75		
			CD 281 = LL			Cut 3,0mm = CF	10,0mm = 10		
			CD 284 = XY			on request: alternative lead forms (axial, 90° - angle, others)		12,5mm = 12	
		CD 287 = GC			Snap-In:				
		CD 28L = QL			4,0mm Pin Length = T4	2 Pin = P2			
		CD 293 = BZ			6,3mm Pin Length = T6	3 Pin = P3			
		CD 294 = BW			Soldering Pin = S4	4 Pin = P4			
		CD 295 = BC				5 Pin = P5			
		CD 296 = KC			preferred				
		CD 297 = BB							
		CD 299 = PG							
		CD 29D = HR							
		CD 29H = QH							
		CD 29L = QL							
		HCP = CP							
		HPM = PM							
		HVC = VC							

Technical Specification SMD Type

Dimensions

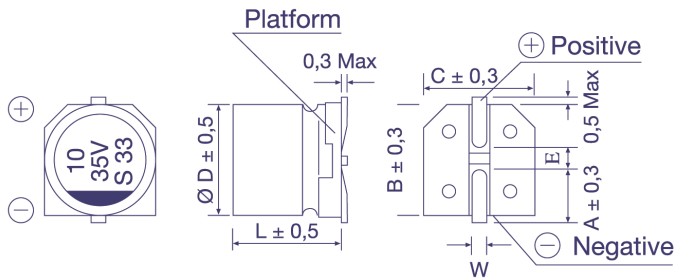

Ø D x L	4x5,4	5x5,4	6,3x5,4	6,3x7,7	8x10,5	8x11,8	10x10,5	10x12,7
A	1,8	2,1	2,4	2,5	2,9	2,9	3,2	3,2
B	4,3	5,3	6,6	6,6	8,3	8,4	10,3	10,4
C	4,3	5,3	6,6	6,6	8,3	8,4	10,3	10,4
E	1,0	1,3	2,2	2,2	3,1	3,1	4,5	4,5
L	5,4	5,4	5,4	7,7	10,5	11,8	10,5	12,7
W	0,5 - 0,8				0,7 - 1,1			

in mm

Taping Dimensions

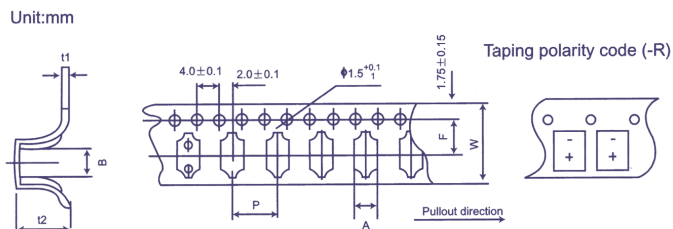

Size (DxL)	w ± 0,3	A ± 0,2	B ± 0,2	P ± 0,1	t2 ± 0,2	F ± 0,1	t1 ± 0,1
4 x 5,4	12,0	5,0	5,0	8,0	5,8	5,5	0,4
5 x 5,4	12,0	6,0	6,0	12,0	5,8	5,5	0,4
6,3 x 5,4	16,0	7,0	7,0	12,0	5,8	7,5	0,4
6,3 x 7,7	16,0	7,0	7,0	12,0	8,4	7,5	0,4
8 x 10,5	24,0	8,7	8,7	16,0	11,0	11,5	0,5
8 x 11,8	24,0	8,7	8,7	16,0	12,3	11,5	0,5
10 x 10,5	24,0	10,7	10,7	16,0	11,0	11,5	0,5
10 x 12,7	24,0	10,7	10,7	16,0	14,0	11,5	0,5

in mm

Soldering Profile (Aluminium Electrolytic Capacitors)

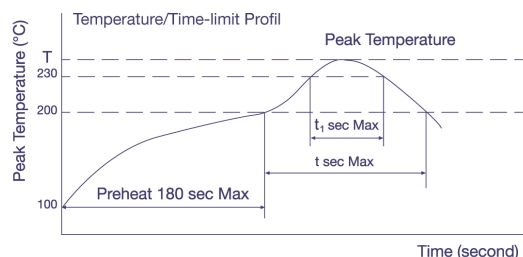

Allowable Range of Peak Temperature

Size	T (°C)	t (second)	t ₁ (second)
Ø 4 ~ 6,3	250	90	40
Ø 8 x 10,5	240	90	30
Ø 10 x 10,5	235	60	30

Diameter	w	D
4; 5	14 ± 1	50 ± 1
6,3	18 ± 1	50 ± 1
8; 10	25 ± 1	50 ± 1
Polymer	25 ± 1	80 ± 1

in mm

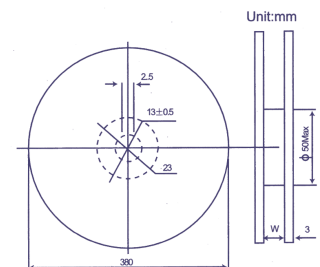

For more details or Soldering Profiles of Radials or Polymer-Capacitors please contact our local Sales Offices.

Technical Specification Snap-In Type

Pin Type: Snap-In
Order Code: T6, T4

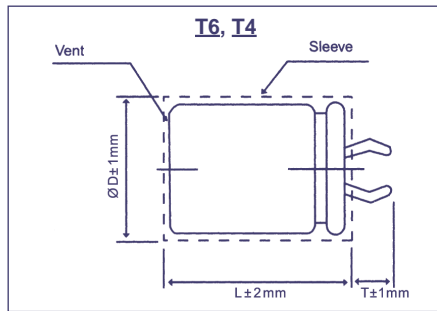

Terminal	T6	T4
Pin Length T	6,3	4,0

Pin Type: Soldering
Order Code: S4

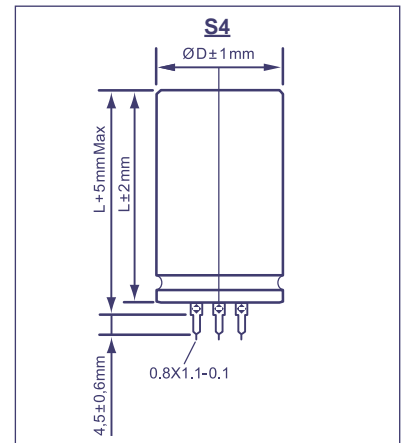

Snap-In Terminal
Order Code: P2, P3, P4

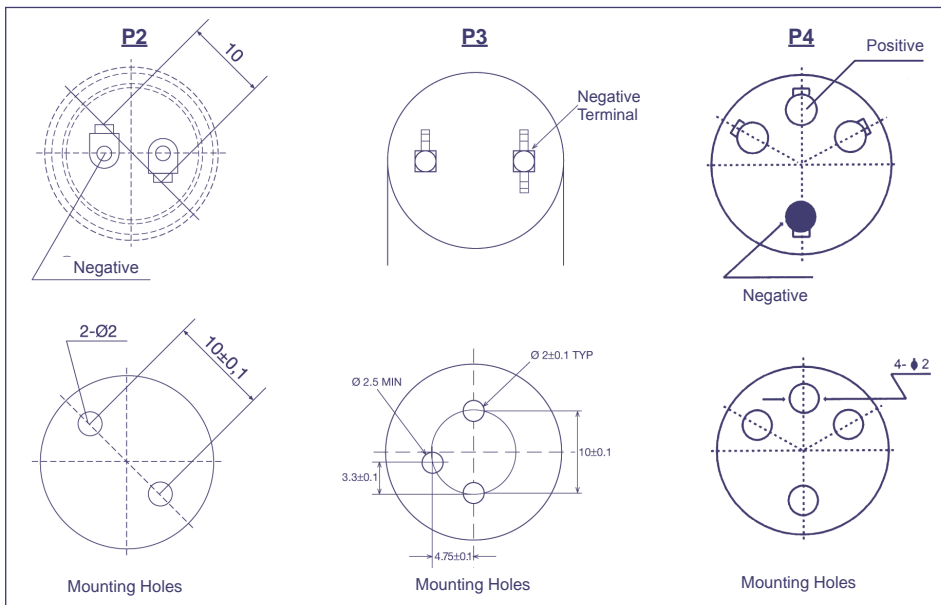

Soldering Terminal
Order Code: P5

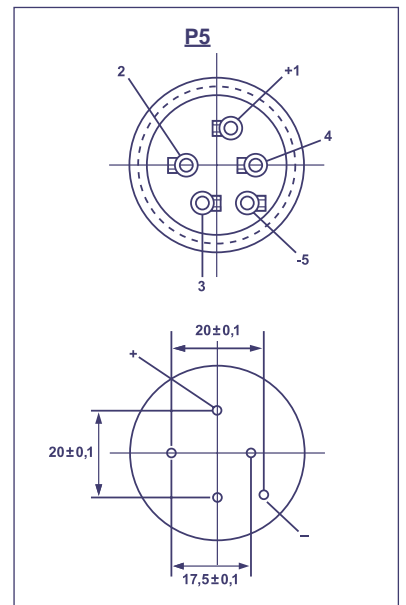

P3 only T4 Terminal

Order Code Screw Type

EC	G	1C	BP	101	M	B	E	160	A361	JExxxxx
Technology	Terminal Type	Rated Voltage Code	Series Code	Capacitance Code	Capacitance Tolerance	Mounting	Diameter	Length	For Terminal Code see tables below	for Specials only
EC = Electrolytic Capacitor	Screw = G	For coding please refer to the pages of ratings	CD 135 = BP	100 = 101	±20% = M	Bolt = B	36 = A	53 = 053		
			CD 136 = PK	1000 = 102	±10% = K	No double sleeve = N	40 = B	65 = 065		
			CD 137 = PX	10000 = 103	+30 / -10% = Q	2 stoppers bracket+double sleeve* = I	51 = C	96 = 096		
			CD 138 = PC		+20 / -0% = R	3 stoppers bracket+double sleeve* = Y	64 = D	100 = 100		
			CD 139 = BL		+50 / -10% = T	No bracket, but double sleeve* = D	77 = E	115 = 115		
				preferred	* Double sleeve for diameter ≥ 51 only		90 = F	236 = 236		
							101 = G			

Technical Specification Screw Type

Dimensions

Standard Housing
Order Code: I, Y, D, N

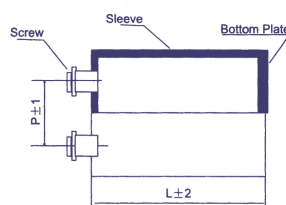
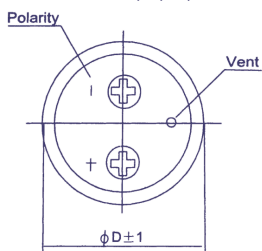

Bolt Housing
Order Code: B

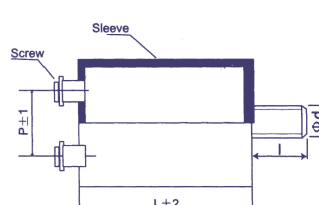

Ø D	Ø d	l
Ø 36	M8	12
≥ Ø 51	M12	16

in mm